



687-1.4

NEW

SpeedRail SB™ Lane Divider

Low friction 2-sided beaded lane divider provides excellent guides for polywrapped containers or PET bottles. Can be cut to length and bent using special rollers and the Valu Guide rail bender. Easy mounting using VG-1568-02 bolts (included). Operating temperature range: -10°F to +180°F.

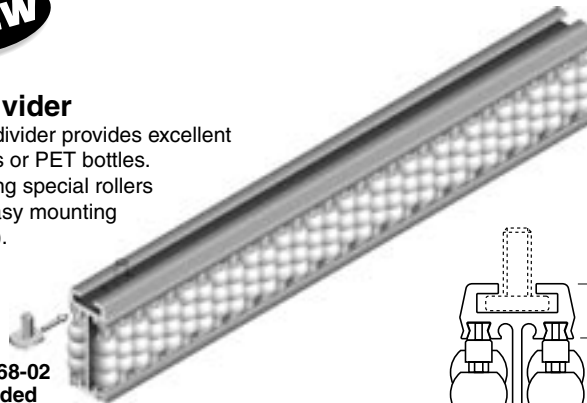

VG-1568-02 included (see page 232)

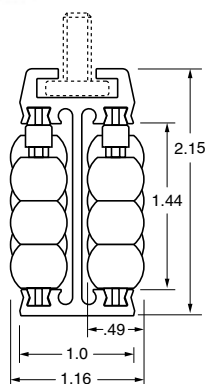
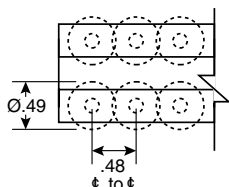

- Easy mounting
- Great for polywrapped containers or PET
- On-site bendable
- Cut to desired length

Material: Aluminum channel, FDA accepted engineered polymer pins, gray acetal beads.

Part Number	No. of Bolts Included*	Length (ft.)
VG-687-1.4-02	3	2
VG-687-1.4-03	3	3
VG-687-1.4-04	3	4
VG-687-1.4-05	4	5
VG-687-1.4-06	4	6
VG-687-1.4-07	5	7
VG-687-1.4-08	5	8
VG-687-1.4-09	6	9
VG-687-1.4-10	6	10

*Bolts included are VG-1568-02



Patent No. 6,516,933

687NP

Nose Plow for SpeedRail SB™ Lane Divider

Material: Nolu-S with stainless steel fastener.

Part Number
VG-687NP-1.4

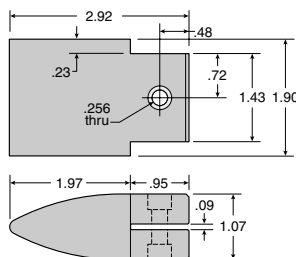

24" min. bending radius in either direction. Field bendable with Valu Guide rail bender on pg. 198 or custom bend request form on pg. 234.

Bead and Roller Guides

687H-1.4

NEW

SpeedRail SB™

Low friction beads provide excellent guides for polywrapped containers or PET bottles. Smaller beads help guide smaller containers. Can be cut to length and bent using special rollers and the Valu Guide rail bender. Easy mounting using VG-1568-02 bolts (included). Operating temperature range: -10°F to +180°F.



VG-1568-02 included (see page 232)



Patent No. 6,516,933

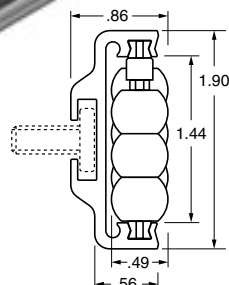

Material: Aluminum channel, FDA accepted engineered polymer pins, gray acetal beads.

Part Number	No. of Bolts Included*	Length (ft.)
VG-687H-1.4-02	3	2
VG-687H-1.4-03	3	3
VG-687H-1.4-04	3	4
VG-687H-1.4-05	4	5
VG-687H-1.4-06	4	6
VG-687H-1.4-07	5	7
VG-687H-1.4-08	5	8
VG-687H-1.4-09	6	9
VG-687H-1.4-10	6	10

*Bolts included are VG-1568-02

687SP

Side Plow for SpeedRail SB™

Material: Nolu-S with stainless steel fastener.

Part Number
VG-687SP-1.4

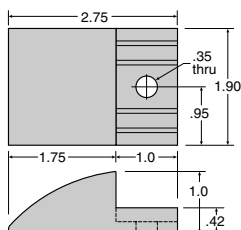
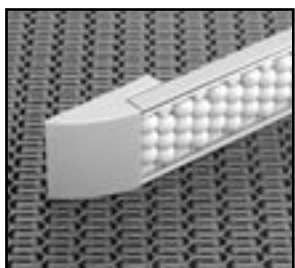

12" min. bending radius in either direction. Field bendable with Valu Guide rail bender on pg. 198 or custom bend request form on pg. 234.