

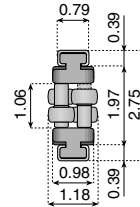

16152

Lane Divider

These low noise, long life, lane dividers offer quick installation and smooth operation. They are designed for rugged boxes and containers. Excellent for accumulation areas.

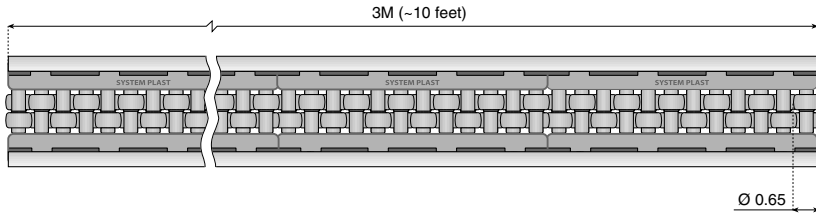
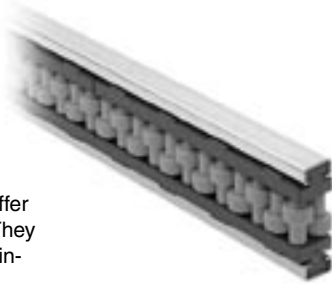

Material: Stainless steel channels. Polyamide straps, acetal rollers and pins, nickel plated brass spacers, stainless steel screws.

Part Number	Length (feet)
16152	3M (~10 ft.)

13833

Roller Module Clamp

Stainless steel clamp for roller modules.

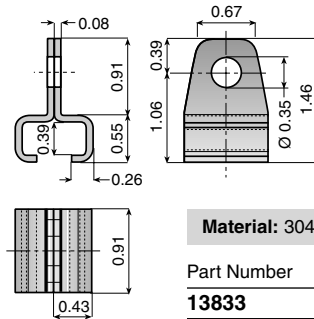

Material: 304 stainless steel.

Part Number
13833

33955

Adjusting Rod

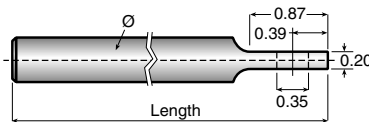

Material: 303 stainless steel.

Part Number	Length (in.)	Ø (in.)
33955	7	1/2

16142

Lane Divider

These low noise, long life, lane dividers offer quick installation and smooth operation. Excellent for accumulation areas.

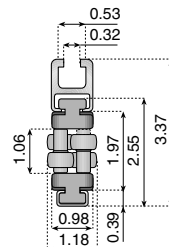
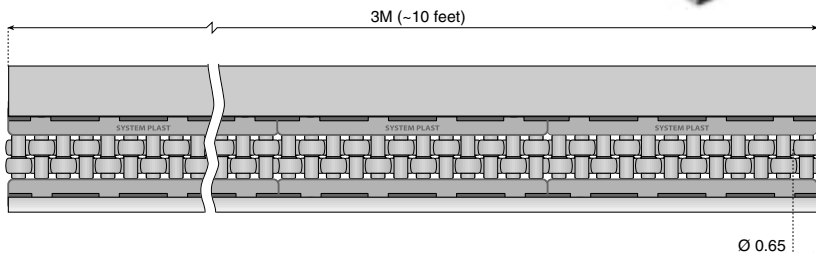

Material: Stainless steel and aluminum channels. Polyamide straps, acetal rollers and pins, nickel plated brass spacers, stainless steel screws.

Part Number	Length (feet)
16142	3M (~10 ft.)

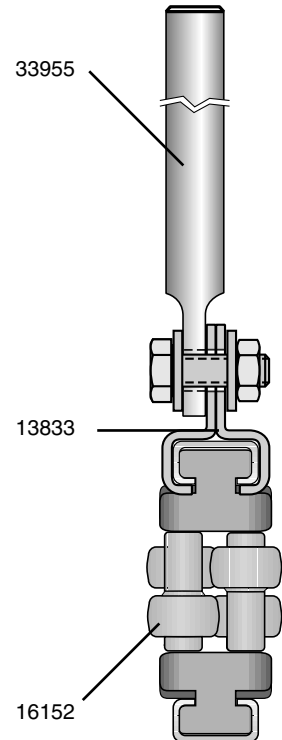

Beard and Roller Guides